

© 2013 Essentra Components. All rights reserved.
 Registered in England, Company No. 547495.
 Registered Office: Essentra plc
 Langford Locks, Kidlington, Oxford, OX5 1HX

Condition of Sale can be found on our website: essentra.com.

Essentra Components does not warrant that the files will be error free and may create new versions ("Upgrades") at any time, which may correct such errors. Essentra Components has no obligation to notify you of such upgrades. Any upgraded file will be published to the website, when it becomes available.

You are not permitted to load any of the files on to a network server for the purposes of distribution to one or more other computer(s) on that network or to effect such distribution. Essentra Components shall not be liable for any loss or damage whatsoever or however caused, arising directly or indirectly from the use of the files.

UNCONTROLLED COPY

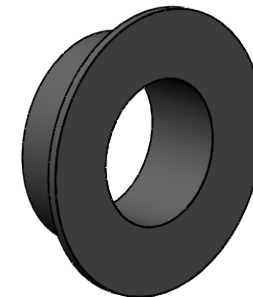
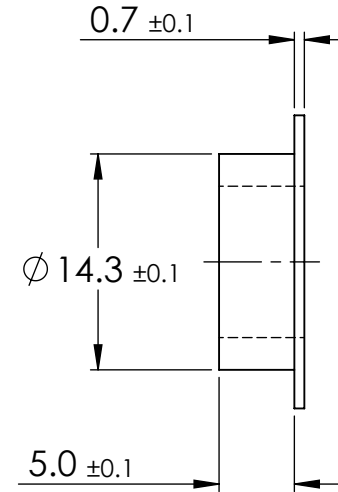
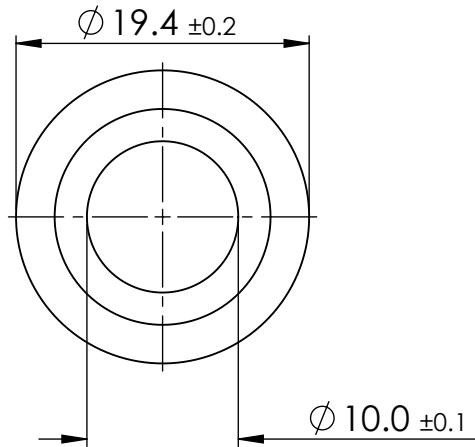

STATUS **APPROVED DRAWING**

UNLESS OTHERWISE STATED

| | | | |
|----------------------|------|-------|------------------------|
| ALL DIMENSIONS IN mm | | | DO NOT SCALE |
| LINEAR TOLERANCE | | | THIRD ANGLE PROJECTION |
| SIZE | (0) | (0.0) | (0.00) |
| 0-10 | ±0.5 | ±0.15 | ±0.10 |
| >10-30 | ±0.5 | ±0.20 | ±0.15 |
| >30-50 | ±0.5 | ±0.30 | ±0.20 |
| >50-100 | ±0.8 | ±0.50 | ±0.25 |
| >100-200 | ±1.5 | ±0.80 | ±0.40 |
| >200-300 | ±2.0 | ±1.20 | ±0.80 |
| >300-500 | ±3.0 | ±2.00 | ±1.00 |
| >500 | ±5.0 | ±3.00 | ±1.50 |

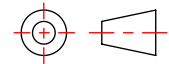

ANGULAR TOLERANCE ±0.5 DEGREES
 UNSPECIFIED RADII 0.25mm
 DRAFT ANGLE 0.5 DEGREES
 DIMENSIONS IN PARENTHESIS ()
 ARE FOR REFERENCE ONLY

| | | | |
|-------------|------------|-------------|------------|
| ITEM CODE | 20464035 | CREATE DATE | 20/03/2025 |
| LEGACY CODE | 12SWS3011B | MATERIAL | PA66 |
| | | COLOUR | BLACK |
| | | FINISH | - |

TITLE:
 SHOULDER WASHER
 -

| | | | | | |
|----------|----------|-------|-----|-------|--------|
| DWG. No. | 20464035 | SCALE | 2:1 | ISSUE | 1 |
| | | | | SHEET | 1 of 2 |

Essentra Components does not warrant that the files will be error free and may create new versions ("Upgrades") at any time, which may correct such errors. Essentra Components has no obligation to notify you of such upgrades. Any upgraded file will be published to the website, when it becomes available.

You are not permitted to load any of the files on to a network server for the purposes of distribution to one or more other computer(s) on that network or to effect such distribution. Essentra Components shall not be liable for any loss or damage whatsoever or however caused, arising directly or indirectly from the use of the files.

UNCONTROLLED COPY

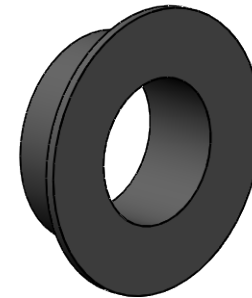
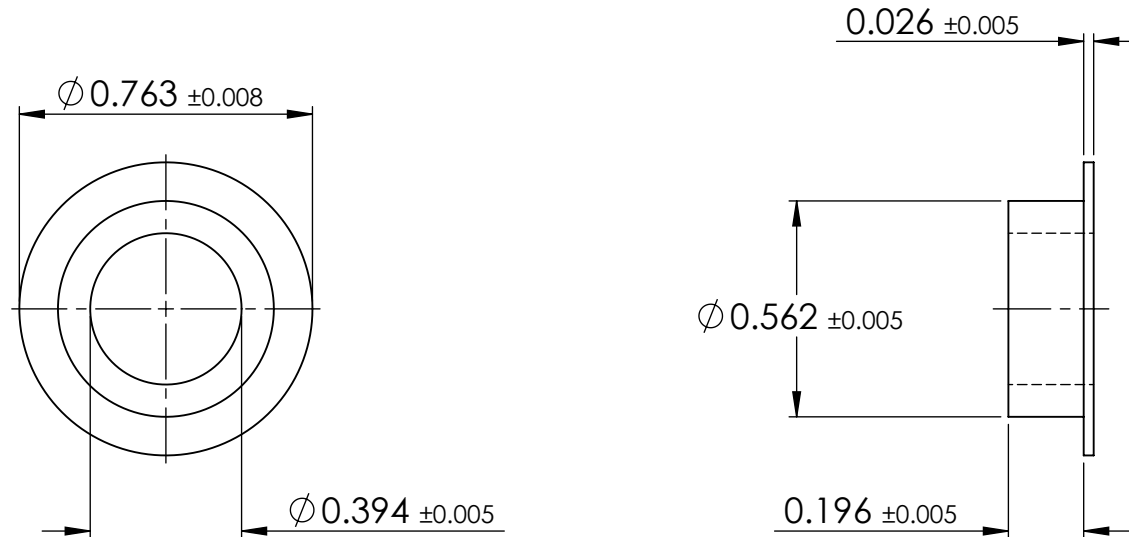

STATUS **APPROVED DRAWING**

UNLESS OTHERWISE STATED

ALL DIMENSIONS IN inches DO NOT SCALE

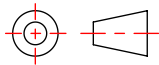
| LINEAR TOLERANCE | | | | THIRD ANGLE PROJECTION | |
|------------------|--------|---------|----------|--|--|
| SIZE | (0.00) | (0.000) | (0.0000) |  | |
| 0 - 0.394 | ±0.020 | ±0.006 | ±0.004 | | |
| >0.394 - 1.181 | ±0.020 | ±0.008 | ±0.006 | | |
| >1.181 - 1.969 | ±0.020 | ±0.012 | ±0.008 | | |
| >1.969 - 3.937 | ±0.031 | ±0.020 | ±0.010 | | |
| >3.937 - 7.874 | ±0.059 | ±0.031 | ±0.016 | | |
| >7.874 - 11.811 | ±0.079 | ±0.047 | ±0.031 | | |
| >11.811 - 19.685 | ±0.118 | ±0.079 | ±0.039 | | |
| >19.685 | ±0.197 | ±0.118 | ±0.059 | | |

| | | | |
|-------------|------------|------------|-------------|
| ITEM CODE | 20464035 | 20/03/2025 | CREATE DATE |
| LEGACY CODE | 12SWS3011B | PA66 | MATERIAL |
| | | BLACK | COLOUR |
| | | - | FINISH |

TITLE:
SHOULDER WASHER

| | | | |
|----------|----------|-------|--------|
| DWG. No. | 20464035 | SCALE | ISSUE |
| | | 2:1 | 1 |
| | | SHEET | 2 of 2 |